



Cover 1:  
Polly Cotton

Cover 3:  
Duke Bottle Green

Cover 2:  
Asra Earth

Light Wood Feet

# Celine Collection

Colours represented are to be used as a guide only.  
Please refer to manufacturers swatch for a more accurate colour match.

Please note that colour shadings can vary slightly from each roll of fabric.  
We cannot guarantee a precise match to these samples or between cut lengths and upholstered goods.

foamflex™  
Award Winning Seating Technology

18/10/2023

# CELINE COVER GUIDE - STANDARD BACK

Please use this guide when ordering the following pieces to clarify cover options.

## STANDARD BACK

LH2, FST, COR, ALU, RH1 Group

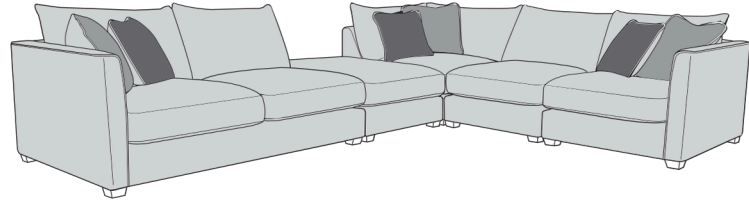

LH1, ALU, COR, FST, RH2 Group

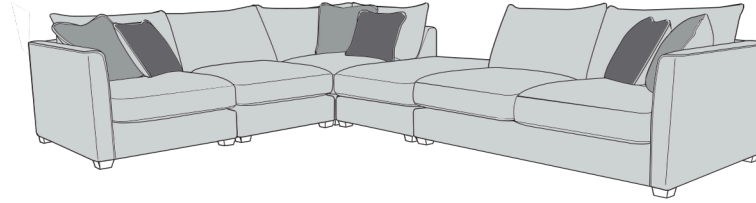

LH2, COR, ALU, RH1 Group

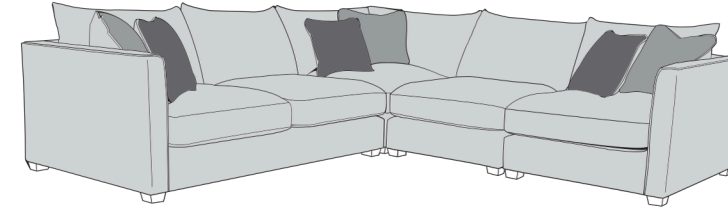

LH1, ALU, COR, RH2 Group

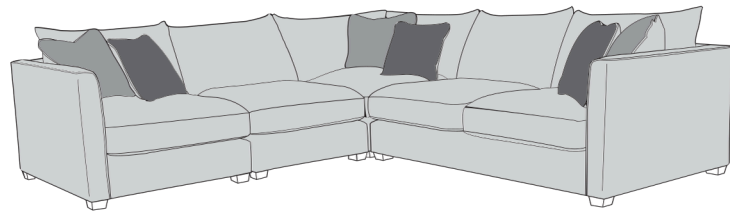

LH2, COR, ALU, FST Group

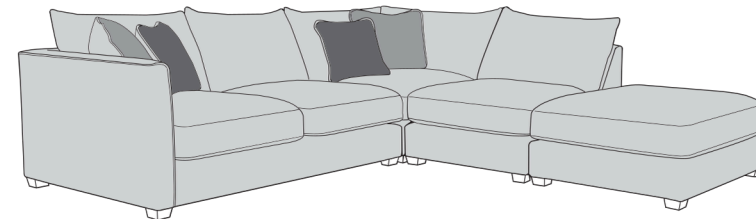

FST, ALU, COR, RH2 Group

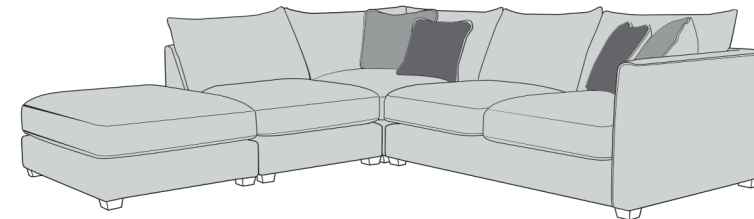

LH2, COR, RH2 Group

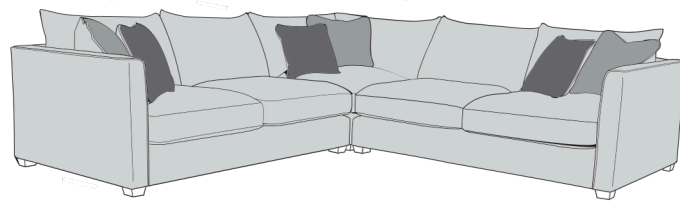

LH2, COR, RH1 Group

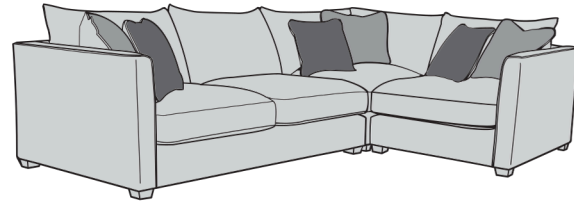

LH1, COR, RH2 Group

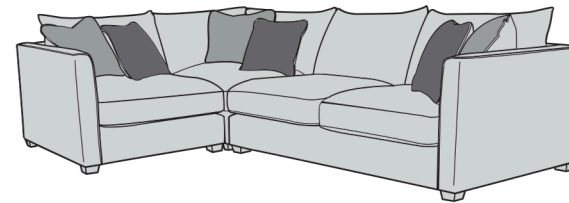

LH1, COR, RH1 Group

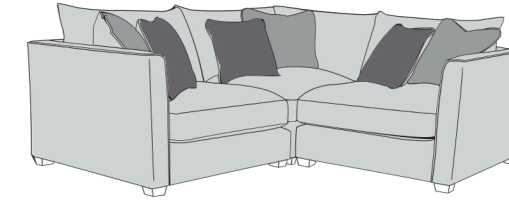

Armless Unit (ALU)

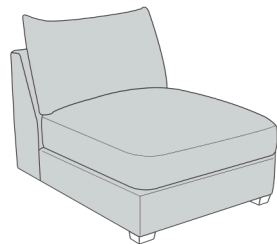

3 Seater Sofa (3ST)

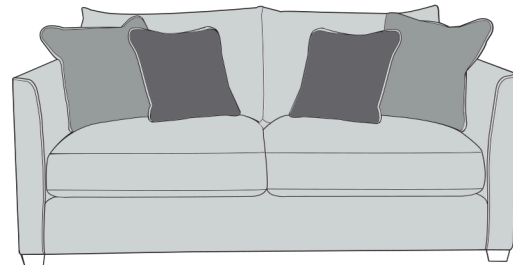

2 Seater Sofa (2ST)

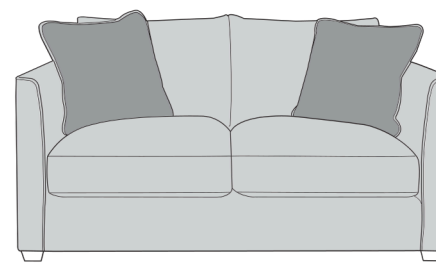

Arm Chair (1ST)

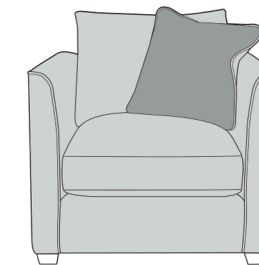

## SUGGESTED ACCENT PIECES

Salute Swivel Chair (SWC)

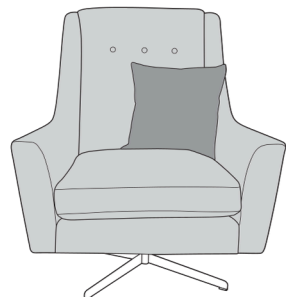

Storage Footstool (FSS)

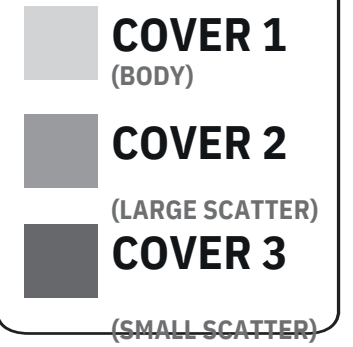
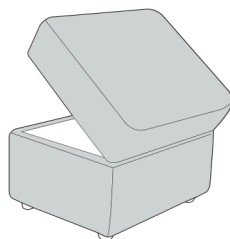

Large Scatter Cushions

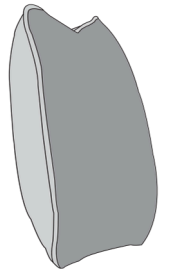

Front = Cover 2  
Piping = Cover1  
Reverse = Cover1

Small Scatter Cushions

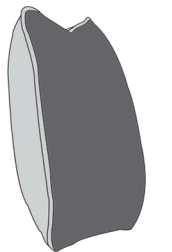

Front = Cover 3  
Piping = Cover1  
Reverse = Cover1



APPROVED MEMBER



# CELINE DIMENSIONS (CM)

| AVAILABLE PIECES LH2, FST, COR,                      | HEIGHT 1 | WIDTH 2 | DEPTH 3 | SEAT HEIGHT 4 | SEAT DEPTH (STD) 5 | SEAT WIDTH 6 | ACCESS DIAGONAL 7 | OUTBACK HEIGHT 8 | ARM HEIGHT 9 | WEIGHT (KG) | SCATTER CUSHION NO. |
|--|----------|---------|---------|---------------|--------------------|--------------|-------------------|------------------|--------------|-------------|---------------------|
| ALU, RH1 GROUP or LH1, ALU, COR, FST, RH2 GROUP      | 86       | 347     | 267     | 47            | 66                 | N/A          | N/A               | 67               | 67           | 167         | 3 Large, 3 Small    |
| LH2, COR, ALU, RH1 GROUP or LH1, ALU, COR, RH2 GROUP | 86       | 269     | 267     | 47            | 66                 | N/A          | N/A               | 67               | 67           | 149         | 3 Large, 3 Small    |
| LH2, COR, ALU, FST GROUP or FST, ALU, COR, RH2 GROUP | 86       | 269     | 258     | 47            | 66                 | N/A          | N/A               | 67               | 67           | 131         | 2 Large, 2 Small    |
| LH2, COR, RH2 GROUP                                  | 86       | 269     | 269     | 47            | 66                 | N/A          | N/A               | 67               | 67           | 140         | 3 Large, 3 Small    |
| LH2, COR, RH1 GROUP or LH1, COR, RH2 GROUP           | 86       | 269     | 192     | 47            | 66                 | N/A          | N/A               | 67               | 67           | 124         | 3 Large, 3 Small    |
| LH1, COR, RH1 GROUP                                  | 86       | 192     | 192     | 47            | 66                 | N/A          | N/A               | 67               | 67           | 108         | 3 Large, 3 Small    |
| LH2/RH2 UNIT   | 86       | 164     | 105     | 47            | 66                 | 155          | 194               | 67               | 67           | 52          | 1 Large, 1 Small    |
| LH1/RH1 UNIT   | 86       | 87      | 105     | 47            | 66                 | 78           | 136               | 67               | 67           | 36          | 1 Large, 1 Small    |
| COR: CORNER UNIT                                     | 47       | 105     | 105     | 47            | 66                 | 66           | 144               | 67               | N/A          | 36          | 1 Large, 1 Small    |
| ALU: ARMLESS UNIT                                    |          | 75      | 105     | 47            | 66                 | 75           | 129               | 67               | N/A          | 25          | N/A                 |
| LARGE FOOTSTOOL (FST)                                |          | 78      | 105     | N/A           | N/A                | N/A          | 128               | N/A              | N/A          | 18          | N/A                 |
| 3 SEATER SOFA (3ST)                                  | 86       | 173     | 105     | 47            | 66                 | 153          | 199               | 67               | 67           | 63          | 2 Large 2 Small     |
| 2 SEATER SOFA (2ST)                                  | 86       | 153     | 105     | 47            | 66                 | 133          | 182               | 67               | 67           | 56.5        | 2 Large             |
| ARM CHAIR (1ST)                                      | 86       | 97      | 105     | 47            | 66                 | 77           | 140               | 67               | 67           | 44          | 1 Large             |
| <b>ACCENT PIECES</b>                                 |          |         |         |               |                    |              |                   |                  |              |             |                     |
| SALUTE SWIVEL CHAIR (SWC)                            | 100      | 9       | 9       | 58            | 60                 | 55           | 121               | N/A              | N/A          | 25.         | 1                   |
| STORAGE FOOTSTOOL (FSS)                              | 45       | 6       | 5       | N/A           | N/A                | N/A          | 75                | N/A              | N/A          | 5           | N/A                 |

\* Hardwood & composite board frame.

\* Dowelled, screwed, glued & stapled joinery.

\* Light and Dark Wood foot options.

\* Reversible fibre filled backs for added comfort.

\* Feather filled scatter cushions included.

\* Optional extra fibre bolster available.

\* Award winning Foamflex seat interior with 5 year guarantee.

Each unit is fully upholstered, with hidden crocodile clips making them suitable for individual use.

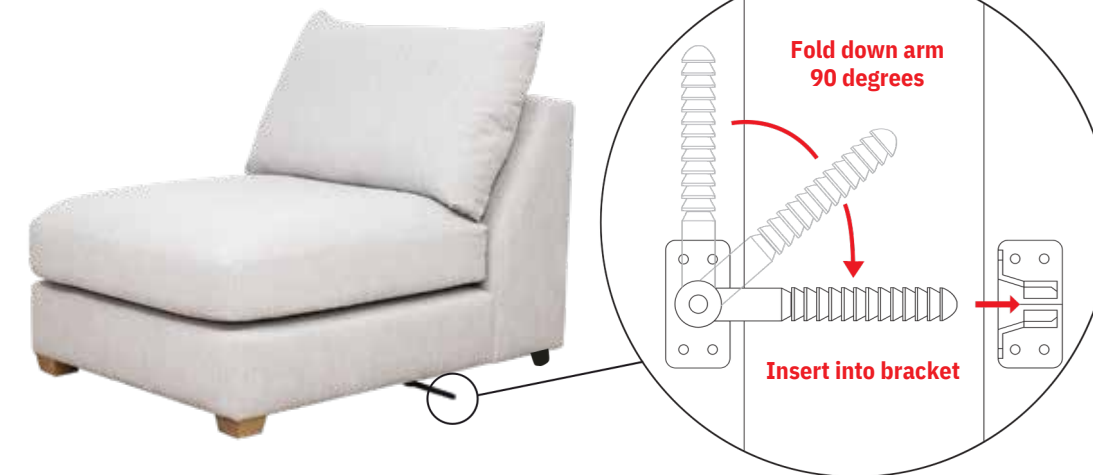

\* Serpentine seat springs & silent wire.

\* Elasticated back webbing.

## DIMENSION GUIDE

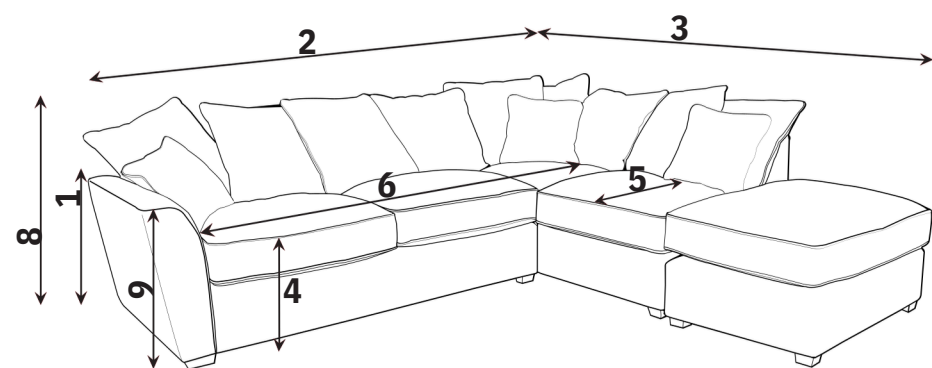

- 1 - HEIGHT
- 2 - WIDTH
- 3 - DEPTH
- 4 - SEAT HEIGHT
- 5 - SEAT DEPTH (STD & PILLOW)
- 6 - SEAT WIDTH

Illustrations used for reference only.

Check the diagonal access dimension to ensure furniture will fit in your home.

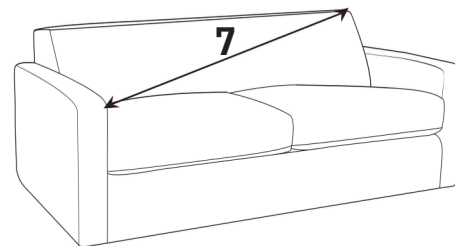

- 7 - DIAGONAL ACCESS
- 8 - OUTBACK HEIGHT
- 9 - ARM HEIGHT

Please note : All dimensions are approximate. Allow tolerance of +/- 2.5cm.

## foamflex

Our new, expertly engineered foam seat interior gives you the comfort of fibre with the retention of foam. Our foamflex seat interiors have been granted the FIRA GOLD Award, a mark of quality under-pinning all necessary testing of the product materials, design and production techniques.

## CARE GUIDE

To improve the longevity of your hand-made furniture, we recommend rotating cushions (where applicable). For further information on maintaining your furniture, please refer to the Care Guide located under the seat platform.



Our foamflex seat interiors have been granted the FIRA GOLD Award, a mark of quality under-pinning all necessary testing of the product materials, design and production techniques.

Beech (light)



Brown (dark)



## FOOT OPTIONS:

Wood is a natural product and will vary in shade/colour from item to item. Feet may require fitting.

