



Cover 1:
Jedi Mustard

Cover 3:
Couture Multi

Cover 2:
Sublime Asphalt

Turned Limed Oak Feet

Beatrice Collection

Extra Flex[®]
Soft, Supportive Seating

Colours represented are to be used as a guide only.
Please refer to manufacturers swatch for a more accurate colour match.

Please note that colour shadings can vary slightly from each roll of fabric.
We cannot guarantee a precise match to these samples or between cut lengths and upholstered goods.

BEATRICE COVER GUIDE: STANDARD BACK ONLY

Please use this guide when ordering the following pieces to clarify cover options.

LH2, COR, RH2 (L2, CO, R2)

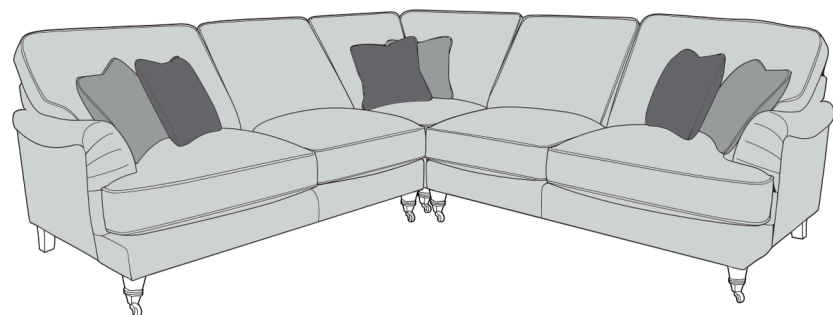

LH2, R2C (L2, R2C)

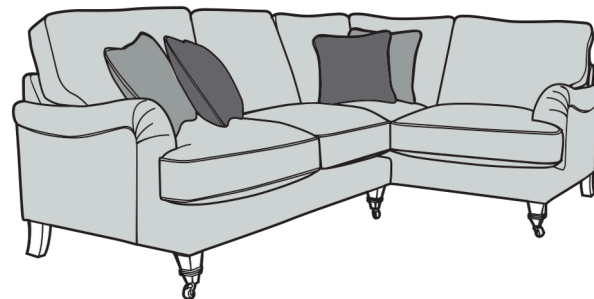

L2C, RH2 (L2C, R2)

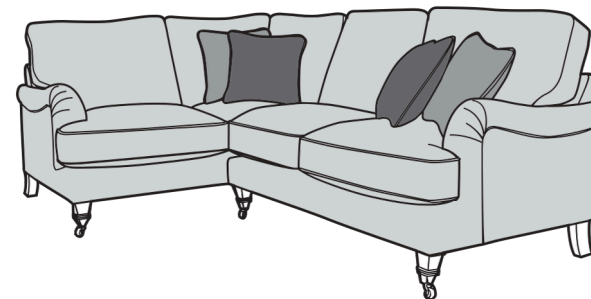

LH2, RFC (L2, RFC)

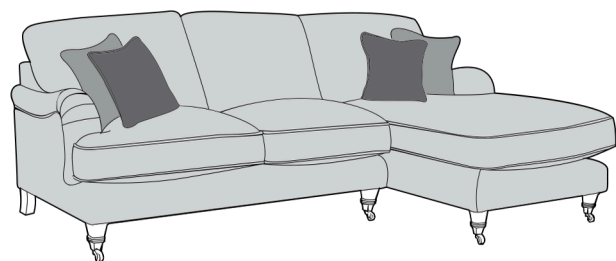

LFC, RH2 (LFC, R2)

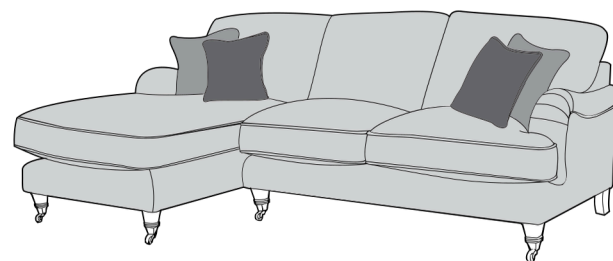

4 Seater Sofa (4ST)

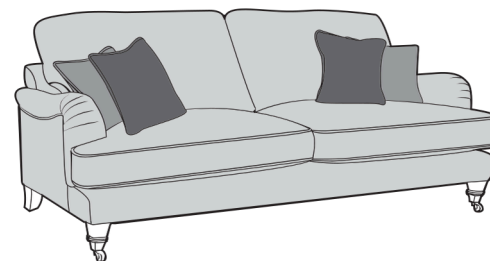

3 Seater Sofa (3ST)

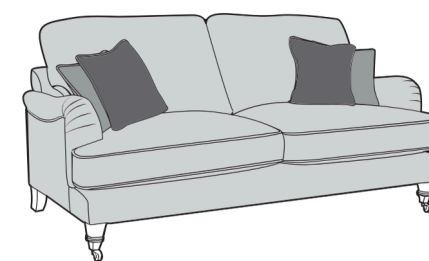

2 Seater Sofa (2ST)

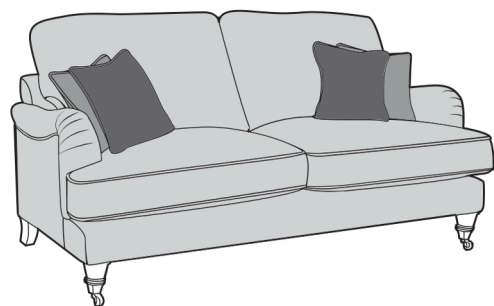

2 Seater 120cm Sofa Bed (2SB)

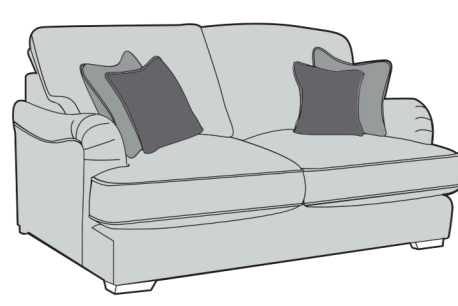

Lounger Chair (LOU)

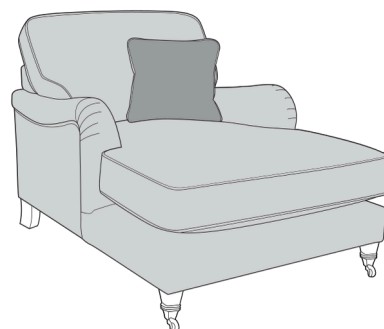

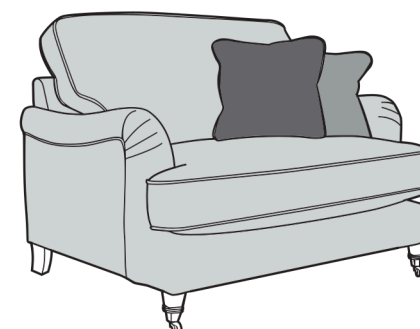

Love Chair (LOV)

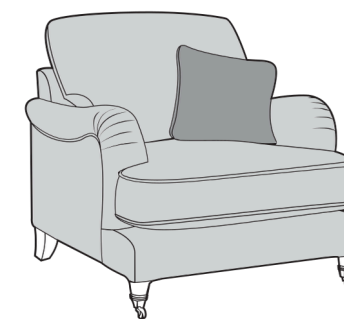

Arm Chair (1ST)



-  **COVER 1**
(BODY)
-  **COVER 2**
(SCATTER)
-  **COVER 3**
(SCATTER)

Standard Back Scatter Cushions



Front = Cover 2
Piping = Cover 2
Back = Cover 2



Front = Cover 3
Piping = Cover 3
Back = Cover 3

SUGGESTED ACCENT PIECES

York Accent Chair (ACH)

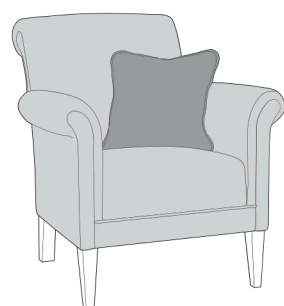

Beatrice Footstool (FST)

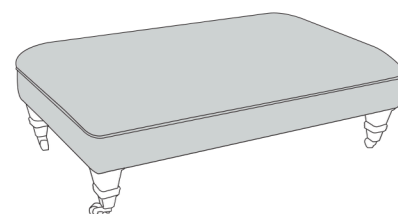

Storage Footstool (FSS)

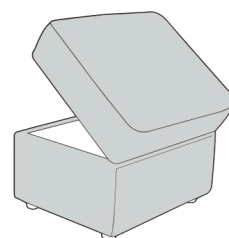

BEATRICE DIMENSIONS (CM)

AVAILABLE PIECES	HEIGHT 1 (FRONT CASTOR) 97	HEIGHT 1 (FRONT TURNED)	WIDTH 2	DEPTH 3	SEAT HEIGHT 4 (FRONT CASTOR)	SEAT HEIGHT 4 (FRONT TURNED)	SEAT DEPTH 5	SEAT WIDTH 6	ACCESS DIAGONAL 7	WEIGHT (KG)	SCATTER CUSHIONS
LH2/COR/RH2 CORNER GROUP	97	93	246	246	54	50	N/A	N/A	N/A	112	6
LH2/R2C CORNER GROUP or L2C/RH2 CORNER GROUP		93	246	176	54	50	N/A	N/A	N/A	91.5	4
LH2/RFC CHAISE CORNER GROUP or LFC/RH2 CHAISE CORNER GROUP	97	93	234	159	54	50	N/A	N/A	N/A	90.5	4
LH2/RH2 UNIT - 2 SEAT ARM UNIT	97	93	150	96	54	50	56	135	178	41.5	2
L2C/R2C UNIT	97	93	176	96	54	50	56	65	198	50	2
LFC/RFC UNIT	97	93	84	159	54	50	N/A	N/A	N/A	40.5	2
COR - CORNER UNIT	97	93	96	96	54	50	56	N/A	131	29	2
4 SEATER SOFA (4ST)											
97 93 210 96 54 50 56 177 230 57 4											
3 SEATER SOFA (3ST)											
97 93 190 96 54 50 56 157 212 53 4											
2 SEATER SOFA (2ST)											
97 93 160 96 54 50 56 130 186 47 4											
LOUNGER CHAIR (LOU)											
97 93 95 136 54 50 98 64 153 37 1											
LOVE CHAIR (LOV)											
97 93 119 96 54 50 56 88 N/A 39 1											
ARM CHAIR (1ST)											
97 93 89 96 54 50 56 59 130 35.5 1											
SOFA BEDS - STD BACK ONLY											
2SB - 120CM STANDARD SOFA BED											
97 (LOW FOOT) N/A 160 96 54 (LOW FOOT) N/A 56 130 186 62 4											
OPEN DEPTH OF SOFA BEDS 226CM											
ACCENT PIECES											
YORK ACCENT CHAIR (ACH)											
85 (YORK FOOT) N/A 76 81 45 (YORK FOOT) N/A 50 48 N/A 19. 1											
BEATRICE FOOTSTOOL (FST)											
35 31 106 65 N/A N/A N/A N/A 124 5 N/A											
STORAGE FOOTSTOOL (FSS)											
45 (GLIDES) N/A 63 50 N/A N/A N/A N/A 75 14. N/A											

5
12.
5

SOFABEDS: SLEEP OPTIONS

STANDARD ACTION & FOAM MATTRESS

A three fold metal action with a sprung 'polyprop' base. Complemented by a high performance foam mattress. For occasional use only.



Mattress Thickness: 6cm

Mattress Length: 185cm

2 fold action is 160Kg total max occupancy weight

120cm sofa bed:

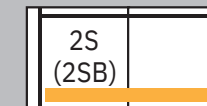

Mattress Width: 113cm

* Hardwood & composite board frame.

* Dowelled, screwed, glued & stapled joinery.

* Wood foot options: Choice of Castor or Turned Front Foot - Full details below

* ExtraFlex high comfort seat cushions.

* Fibre filled scatters included.

* Fibre filled reversible backs for added comfort.

* Serpentine seat springs & silent wire.

* Superloop back springs.

DIMENSION GUIDE

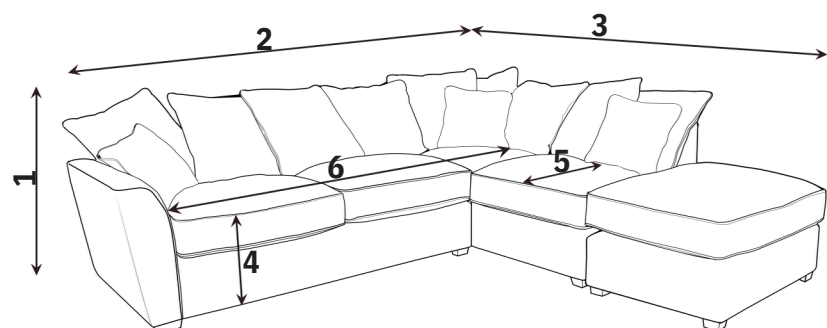

- 1 - HEIGHT
- 2 - WIDTH
- 3 - DEPTH
- 4 - SEAT HEIGHT
- 5 - SEAT DEPTH (STD & PILLOW)
- 6 - SEAT WIDTH

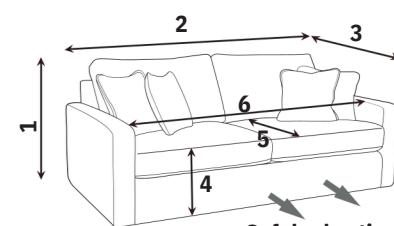

Check the diagonal access dimension to ensure furniture will fit in your home.

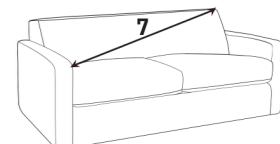

Illustrations used for reference only.

Extra Flex®

A high density foam base seat interior with a hand-rolled carded fibre, channelled topper which provides both softness and support.

CARE GUIDE

Extraflex seat cushions should be **plumped up on a regular basis** to help maintain the aesthetical appeal of your upholstery, the plumping of cushions is essential to help retain the comfort and softness of any piece of upholstered furniture.

To improve the longevity of your hand-made furniture, we recommend rotating cushions (where applicable).

For further information on maintaining your furniture please refer to the care guide located under the seat platform.

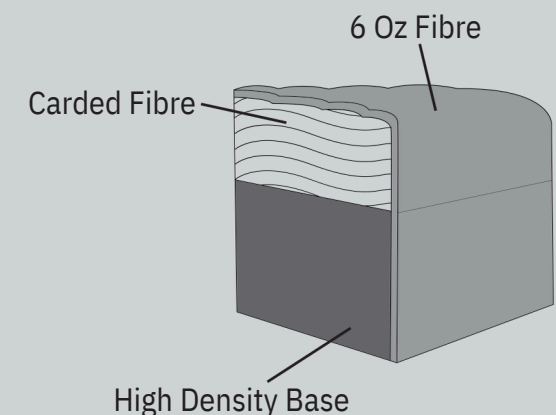

FOOT OPTIONS:

- | | | | |
|--|----------------------|----------------------------|---------------|
| FRONT CASTOR | FRONT TURNED | BACK FEET | SOFA BED FEET |
| Antique /Beech / Antique /Beech /
Chrome Chrome Brass Brass | Antique Limed
Oak | Antique Beech Limed
Oak | Antique Beech |
| | | | |
| | | | Limed
Oak |

Please note : All dimension are approximate. Allow tolerance of +/- 2.5cm.

Wood is a natural product and will vary in shade/colour from item to item. Feet may require fitting.